

Lampada a sensore per interno LED

RS PRO P3 S

Bianco neutro

EAN 4007841 056117

Art. n. 056117



Lampada a sensore per interno LED

RS PRO P3 S

Bianco neutro
EAN 4007841 056117
Art. n. 056117



Schema elettrico Master

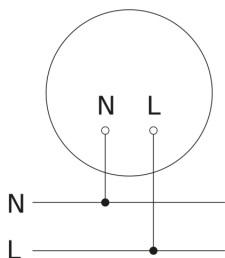

Schema elettrico Master-Master collegamento in rete

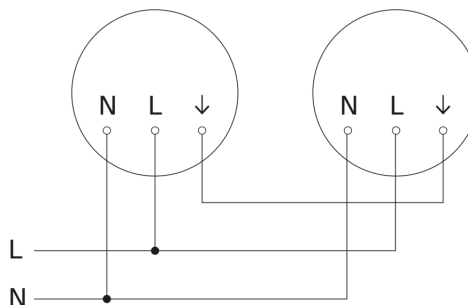

Schema elettrico Master-Slave collegamento in rete

